

GRIN Lens Gripper for GRIN-Lenses, Needle Endomicroscopes and High NA Objectives

GRIN Lens Gripper

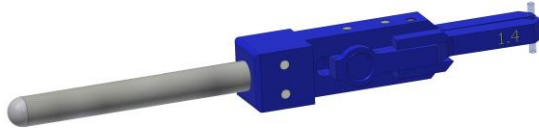

Applications and properties

- Basic Unit - GRIN Lens Gripper
- Holding device for grin lenses
- different prism groove sizes available for diameter: 0.5 / 0.7 / 1.0 / 1.2 / 1.4 mm
- springy-loaded snap system for easy pick up and handle micro-optics
- durable anodized aluminum surface

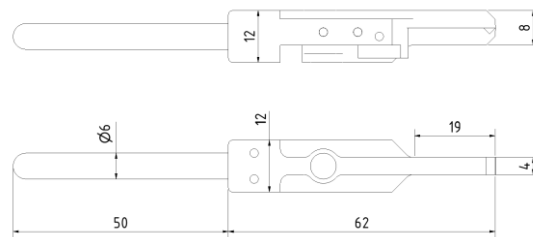

Tool - Table support

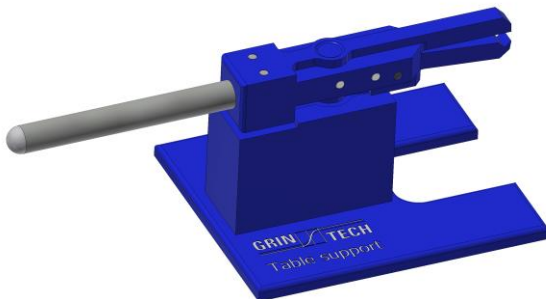

Applications and properties

- Table support for GRIN Lens Gripper
- for cleaning and inspection on table
- horizontal and vertical storage of the lens axis possible
- Shelf heights available in 8.5mm and 27mm from the table surface
- magnetic holder
- durable anodized aluminum surface

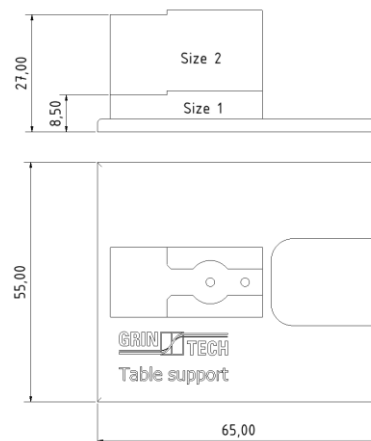

Tool - Microscope support

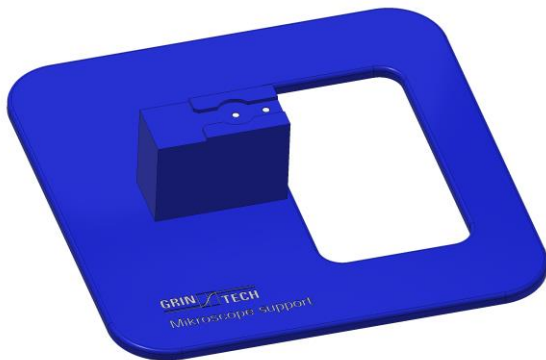

Applications and properties

- Microscope support for GRIN Lens Gripper
- for cleaning and inspection on Microscope
- horizontal and vertical storage of the lens axis possible
- Shelf heights available in 8.5mm and 27mm from the Support surface
- magnetic holder
- durable anodized aluminum surface

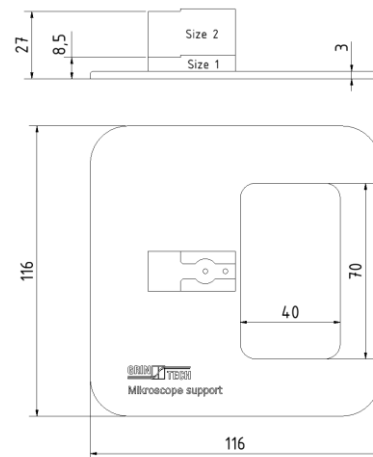

Tool Mounting Bracket

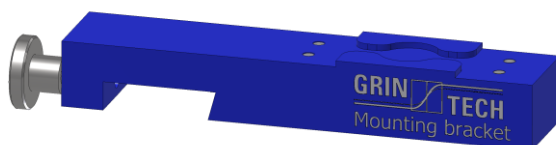
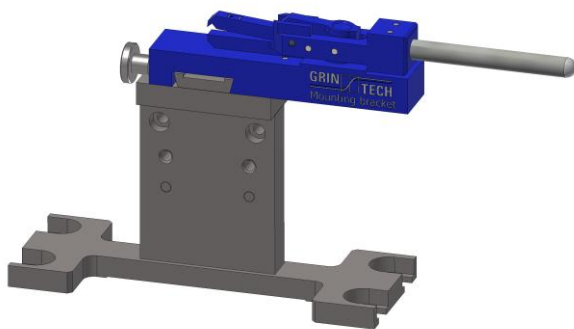

Applications and properties

- for mounting GRIN Lens Gripper on Newport ULTRAalign™ system
- measuring and inspection on Newport ULTRAalign™ system
- magnetic holder
- durable anodized aluminum surface

