

PosUnit 3x for GRIN-Needle Endomicroscopes and High NA Objectives

XYZ Stage and objective mounting to connect and align to microscope objectives

PosUnit 3X

Applications and properties

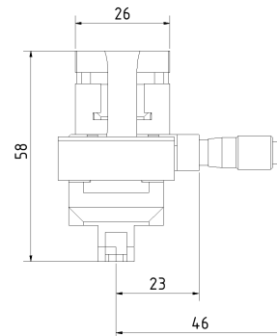
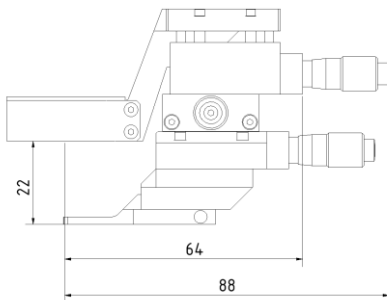
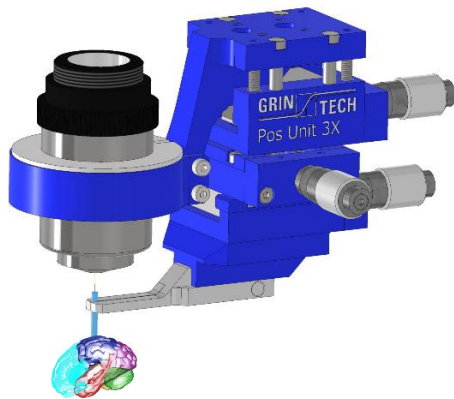

- holding, handling and three-axis-positioning of GRIN-microsystem relative to microscope objectives
- mounting for microscope objective diameter 30mm (standard)
- smaller microscope objective diameters are possible with assistance of an adapter ring
- stable and reliable construction of the XYZ-stage
- adjustment travel: X - 5 mm, Y - 5 mm, Z - 5 mm with scale reading in all axis, bar distance 10 μ m.
- easy pick and drop of GRIN Lenses with a resiliently mounted snap system
- Jaw seat fits exactly to the jaws of the previous model
- durable anodized aluminum surface
- clamping unit not included

Clamping unit

Applications and properties

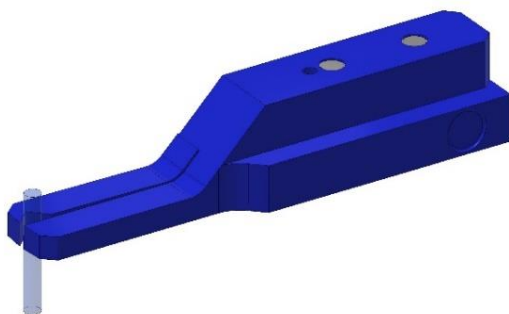

- Holding device for grin lenses to be accommodated within the Pos Unit 3X
- different prism groove sizes available for diameter: 0.5 / 0.7 / 1.0 / 1.2 / 1.4 mm
- resiliently mounted snap system for easy pick and drop and handle of GRIN Lenses, now guided by precise axis
- magnetic holder for PosUnit 3X
- durable anodized aluminum surface

